BuzziNest Pod

Product Specification Sheet

This document contains technical information about the BuzziNest Pod



www.buzzi.space



Silent workspaces anywhere

BuzziNest Pod is all you need to erase distracting noise from any workplace. The compact acoustic privacy booth offers a private space to work and take calls, and can additionally accommodate up to four people to hold face-to-face meetings and collaborations in any open space without disturbing others, and most importantly, being disturbed. Due to its upholstered exterior and fabric panels on the interior, BuzziNest Pod effectively dampens sound from every direction to create maximum peace and quiet for everyone in the office, whether you are working inside BuzziNest Pod or out.

BuzziNest Pod is also customizable with high-quality materials and furniture. Choose from a wide range of fabrics, frames, shelf and table finishes, seating options, and table heights. The mobile BuzziNest Pod can easily fit into an existing space and comes fully packaged with a top-of-the-line motion sensor fresh air ventilation system, automatic LED lighting system, main power outlet (230V), and two USB chargers (type A and C).

Design by BuzziSpace Studio

General



BuzziNest Pod

Structure: Laminated poplar plywood with visible trim



Cover: Inside: Felt, Felt Printed or 3D pattern in Fabric or Trevira CS|CS+

Outside: Fabric covered foam with Fabric or Trevira CS|CS+ or White laminated shell



Flat Packed

Installation time 2 hours, including unboxing

Optional Table Low | High with electrification



BuzziNest Cube

BuzziMilk Stool

BuzziMilk Bar

Acoustics



Absorption



Attenuation



Low Tone



Mid tone



High tone

Content

| | |
|----------------|----|
| Configurations | 3 |
| Components | 4 |
| Fabrics | 8 |
| Finishes | 9 |
| Dimensions | 10 |
| Acoustics | 13 |

Configurations

BuzziNest Pod

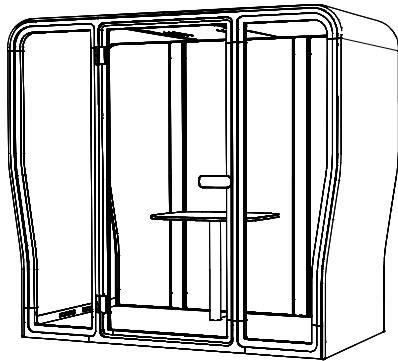

BuzziNest Pod

Structure: Laminated poplar plywood with visible trim



Cover: Inside: Felt, Felt Printed or 3D pattern in Fabric or Trevira CS+
Outside: Fabric covered foam with Fabric or Trevira CS+

Power:

Mains supply: 230V, 50 Hz, max 10A

Stand-by consumption: 1,25W

Consumption when in use: 18,75W

Internal fuses: 2 x 10A glass fuses
(5 x 20mm, speed T)

Output:

Table socket – 230V, 50Hz, max 6A

Twin USB charger – type A and C, max 5A at 5VDC
combined



Lighting unit:

Power usage: 14W

Input: 230V / 50Hz

Lumen output: 1260 lumen

Color Temperature: 4000K

Color Rendering Index: >80



Ventilation unit:

Power usage: 5,76W

Input: 12V dc

Air flow rate when occupied: 16l/s

Air flow rate after 5 mins no occupation: 8l/s

Air flow rate stand-by mode, after 15 mins no occupation: 3l/s



Installed

Width: 240 cm | 94.5"

Depth: 125 cm | 49.2"

Height: 218 cm | 85.8"



2 palletized crates

Crate 1

Length: 222 cm | 87.5 "

Height: 132 cm | 52 "

Width: 65 cm | 25.5 "

Crate 2

Length: 222 cm | 87.5 "

Height: 132 cm | 52 "

Width: 88 cm | 34.5 "



590 kg | 1300 lbs

460 kg | 1014 lbs

483 kg | 1065.8 lbs

Optional Table Low | High with electrification



BuzziNest Cube

BuzziMilk Stool

BuzziMilk Bar

Components

Outside

The outside shell is available in Fabric, Trevira CS+



Fabric



Trevira CS+

Inside

The inside cover is available in Felt, Felt Printed, Fabric* or Trevira CS+*
(*only in combination with 3D Rib)



Felt



Felt Printed



3D Rib Fabric/ Trevira CS+

Floor Cover

The floor cover is always in black carpet.



Frame

Frame is available in Laminated plywood White, Black or Truffle Grey



White



Black



Truffle Grey

Door Handle

Material: Oak with inlay in same color as frame



Table Low | High including electrification (optional)







Table Low | High in Oak or Laminated plywood White, Black or Truffle Grey with visible trim.

Mains power outlet and 2 USB chargers (type A and C) max 5A at 5VDC combined.

When the BuzziNest is selected without table containing electrification, a Wieland connector is foreseen underneath the carpet to accommodate a 3rd party electrification unit.



Available for:

-  NL|DE|LUX
-  BE|FR
-  UK
-  AUS
-  CH
-  CN

Lighting

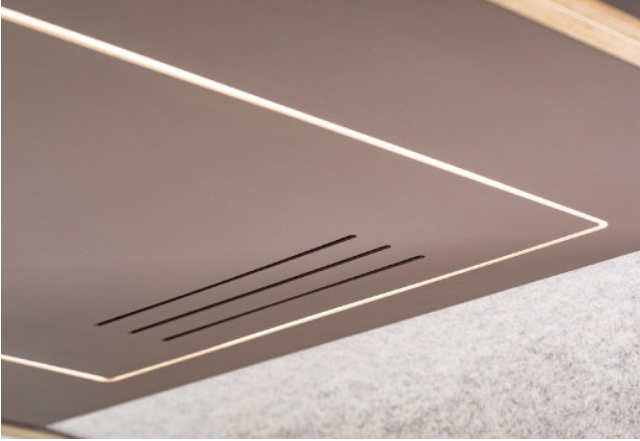

Integrated LED Light
Power usage: 14W
Input: 230V / 50Hz
Lumen output: 1260 lumen
Color Temperature: 4000K
Color Rendering Index: >80

Ventilation



For healthy air circulation there is a integrated ventilation. Cutout for sprinkler possible.
(please reach out to customer service for instructions)

Power usage: 5,76W
Input 12V dc
Air flow rate:
- when occupied: 16l/s
- after 5 mins no occupation: 8l/s
- stand-by mode, after 15 mins no occupation: 3l/s

Power Connection

You can choose where to connect the power supply: at the side or on top.
Selecting the proper power inlet can be done by a switch situated behind the internal acoustic panels.



Wheels

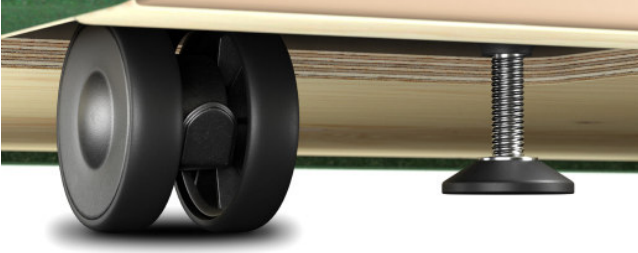

The BuzziNest Pod is moveable by the 4 wheels underneath. Floor adjusters are integrated for leveling.

BuzziNest Cube (optional)



BuzziNest Cubes, in combination with the low table, are the ideal elements to hold a comfortable meeting.

BuzziMilk Stool (optional)



Combine BuzziNest Milk with the low table to accommodate short meetings.

BuzziMilk Bar (optional)



BuzziMilk Bar stools pair perfectly with the high table.

Fabrics

Felt

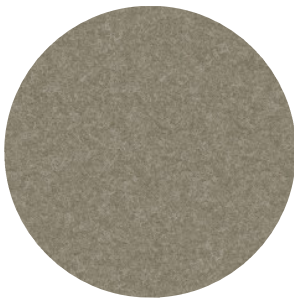

Composition 100% Recycled P.E.T. Felt, latex backing

Weight 1.000 g/m² | 29.49 oz/yd²

Abrasion resistance >7.000 Martindale

Flammability EU: EN 13501.1 + A1/2009 Class B-s1,d0
USA: ASTM E84 Class A certified

Fastness to light USA 5



Printed Felt



Composition 100% Recycled P.E.T. Felt, latex backing

Weight 1.000 g/m² | 29.49 oz/yd²

Abrasion resistance >7.000 Martindale

Flammability EU: EN 13501.1 + A1/2009 Class B-s1,d0
USA: ASTM E84 Class A certified

Fastness to light USA 5



Fabric

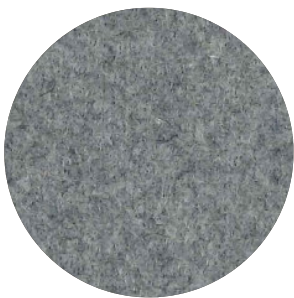

Category A

Composition 70% Recycled Wool, 25% Recycled Polyacryl,
5% Recycled Other Fabrics

Weight 405 g/m² | 11.94 oz/yd²

Abrasion resistance 40.000 Martindale, 50,000 Wyzenbeek

Flammability EU: EN 1021.1/2006 | BS EN 1021.1/2006 (cigarette).
EN 1021.2/2006 | BS EN 1021.2/2006 (match)
USA: CAL TB 117 | ASTM E84 CLASS A

Fastness to light EU: 4 | USA 4

Fastness to rubbing EU: Wet 3-4 | Dry 4-5

Fastness to crocking USA: Wet 5 | Dry 5



Trevira CS+ | CS

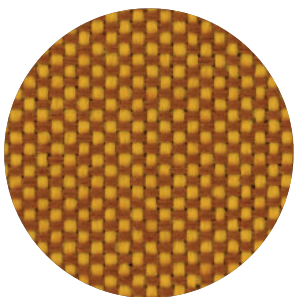

Category A

Weight 420 g/m² | 12.39 oz/yd²

Composition 100% Polyester, Trevira CS

Abrasion resistance 100.000 Martindale, 90,000 Wyzenbeek

Flammability BS 5852 part II: CRIB 5 | BS 7176 Medium Hazard
USA: CAL TB 117 | M1 | B1 | EN 1021/1-2 | C1 |
IMO Res. A652 (16)

Fastness to light EU: 6 | USA 5

Fastness to rubbing EU: Wet 4-5 | Dry 4-5

Fastness to crocking USA: Wet 5 | Dry 5



Finishes

Laminated Plywood with visible lining

Frame and table



White



Black

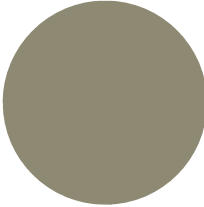

Truffle Grey



Plywood lining

Wood

Door handle and table



Oak

Dimensions

BuzziNest Pod

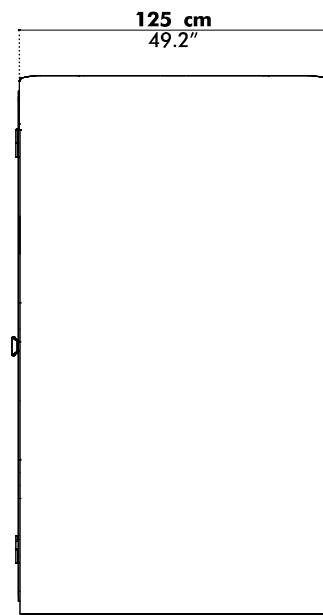
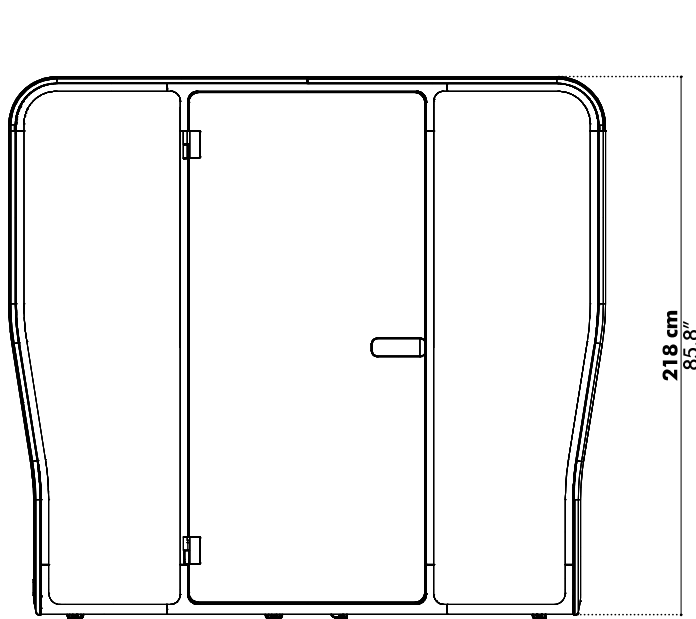
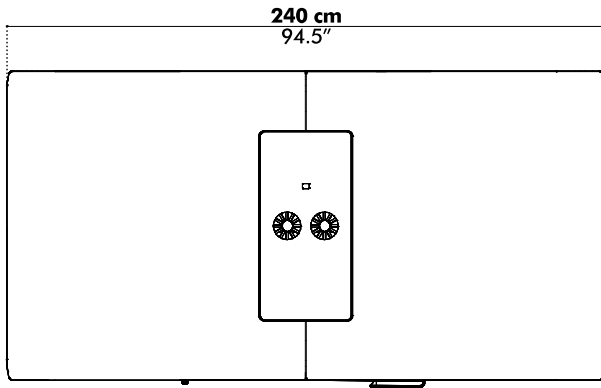

Table low

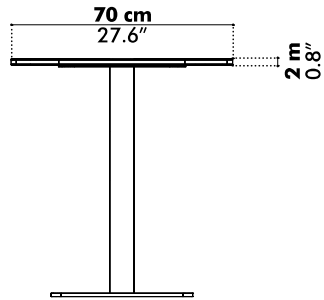
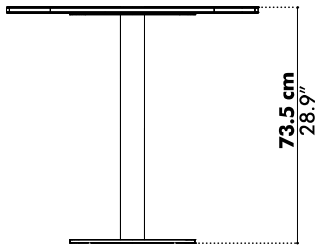
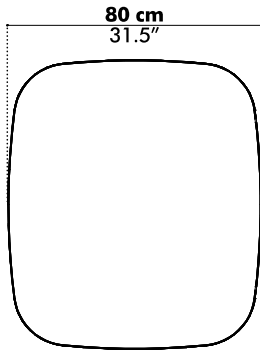
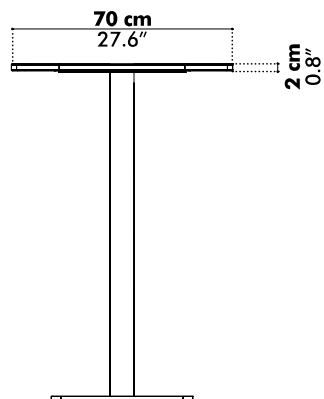
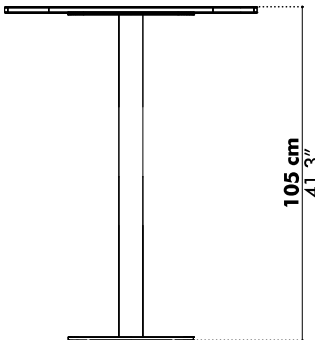
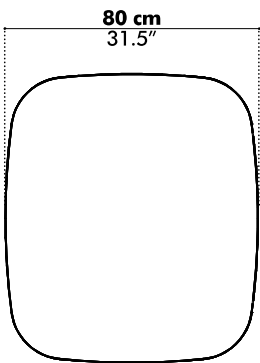
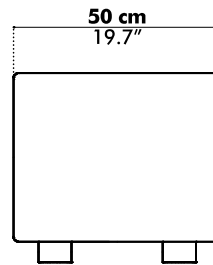
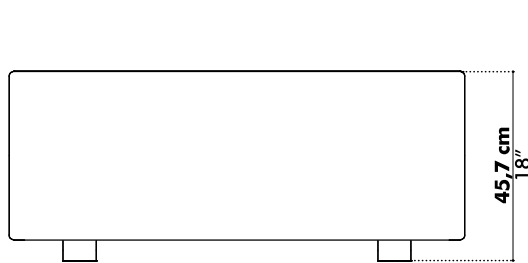
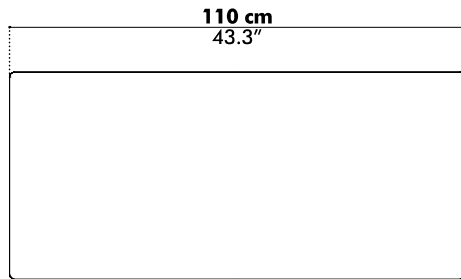

Table High



BuzziNest Cube



Acoustics

Sound blocker



- a) Exterior: upholstered foam
- b) Interior: acoustic Felt or 3D Rib foam pattern
- c) Glass with acoustic foil

Peace and quiet inside

27dB sound reduction, a conversation is turned into an indistinguishable whisper.

Acoustic Principles



Max. absorption on the outside



Max. attenuation on the inside

High performer on all frequencies, especially speech frequencies



Low tones



Mid tones



High tones