



---

# BuzziShade 220-240V

## Product Specification Sheet

---

This document contains technical information about the BuzziShade Pendant and Standing

---

•BUZZI  
SPACE

[www.buzzi.space](http://www.buzzi.space)









**The BuzziShade combines lit surroundings with acoustic performance.**

The design prevents eavesdroppers from hearing your private conversations, and reduces external noise levels to a minimum. The BuzziShade is extremely versatile. The perfect addition to any office, waiting room or restaurant and is ideal for large-scale events. Be creative in colour by adding a layer of fabric to the BuzziFelt shades. The BuzziShade is the culmination of an artistic collaboration between BuzziSpace and the four young Belgian furniture designers of Stal Collectief.

Designed by Stal Collectief

---

## General

-  Pendant
-  BuzziFelt cover
-  Powder coated metal frame
-  Fabric power cord
-  Input Voltage: 220 - 240V
-  Input Frequency: 50/60Hz
-  Class: 1
-  Dry usage
-  Assembled

---

## Acoustics

-  Absorption
-  Mid Tones
-  High Tones

---

## Content

Configurations	3
Technical components	5
Fabrics	8
Dimensions	10
Acoustics	15

# Configurations

## BuzziShade Pendant

◆ Medium | Large

BuzziFelt cover with lace  
Metal frame in black (RAL 9005), white (RAL 9010),  
🌲 uncoated aluminium or fluorescent orange (RAL 2005)  
Fabric power cord in black, red or fluorescent orange

✂ Height: 42 cm (Medium) or 62 cm (Large)  
✂ Diameter: Ø 40 cm - Ø 74 cm (Medium)  
Ø 59 cm - Ø 112 cm (Large)

💡 E27 Fitting (Max. 60W)  
Excl. Bulb

⚖ Medium: 4 kg  
Large: 8 kg

... Lace: black | white | fluorescent orange  
Optional extra layer Fabric | Terra | Hero  
inside or outside  
Black or alu cables 2 - 5 m

⚠ If installing on suspended ceiling, verify load capacity prior to installation.

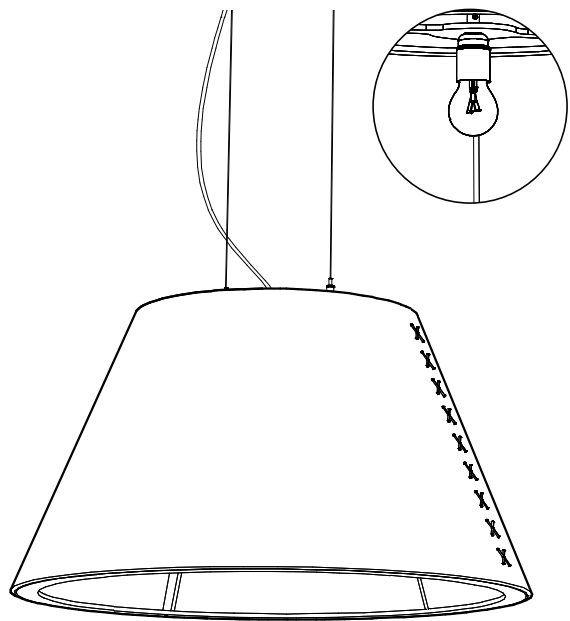

## BuzziShade Pendant LED

◆ Medium | Large

BuzziFelt cover with lace  
Metal frame in black (RAL 9005), white (RAL 9010),  
🌲 uncoated aluminium or fluorescent orange (RAL 2005)  
Fabric power cord in black

✂ Height: 42 cm (Medium) or 62 cm (Large)  
✂ Diameter: Ø 40 cm - Ø 74 cm (Medium)  
Ø 59 cm - Ø 112 cm (Large)

💡 Wattage: 32W  
Lumen Output: 1500 lumen (LED light source)  
Color Temperature: 3000K  
Color Rendering Index: 90  
Dimmable: 1-10V Protocol (DALI on request)

⚖ Medium: 6 kg  
Large: 10 kg

... Diffusor: frosted glass globe or 38° reflector spot  
Lace: black | white | fluorescent orange  
Optional extra layer Fabric | Terra | Hero  
inside or outside  
Black or alu cables 2 - 5 m

⚠ If installing on suspended ceiling, verify load capacity prior to installation

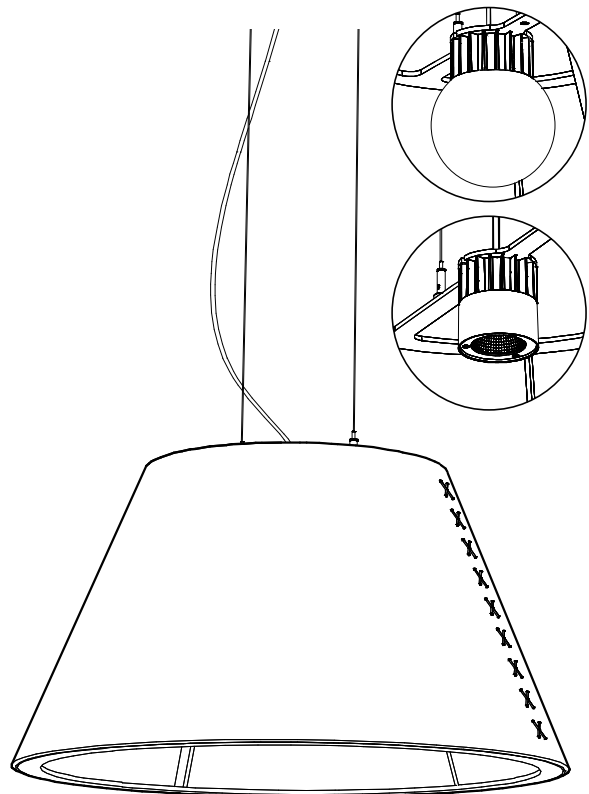

# Technical components

---

## BuzziShade Pendant

### Ceiling canopy

Powder coated metal canopy in black (RAL 9005) or white (RAL 2010)  
Including mounting bracket

Height: 2,6 cm  
Diameter: 12 cm



### Frame

Metal frame available in following colors:

Powder coated white		RAL 9010
Powder coated black		RAL 9005
Fluorescent orange		RAL 2005
Alu		not powder coated



# Technical components

---

## BuzziSol LED Pendant

### Ceiling canopy



Powder coated metal canopy in black (RAL 9005)  
Including mounting bracket

Width: 14 cm  
Length: 28 cm  
Height: 4 cm

### Frame



Metal frame available in following colors:

Powder coated white	RAL 9010
Powder coated black	RAL 9005
Fluorescent orange	RAL 2005
Alu	not powder coated

### Heat sink

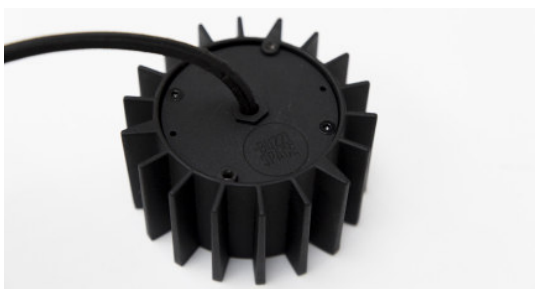

The light element consists out of a black powder coated metal heat sink fitted with a C.O.B. LED source.

## Globe

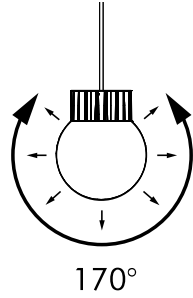

The BuzziSol Globe is finished with a frosted glass globe, to create a decorative light effect 170° around enlightening the inside of the BuzziShade.

### Specification overview

Standard: 3000K | 1-10V DIM

On request: 3000K | DALI DIM

## Spot

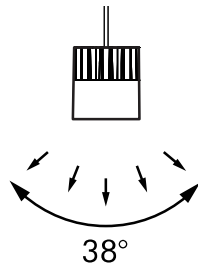

The BuzziSol Spot is finished with a 38° reflector to direct the light towards the surface.

### Specification overview

Standard: 3000K | 1-10V DIM

On request: 3000K | DALI DIM

# Fabrics

## Felt

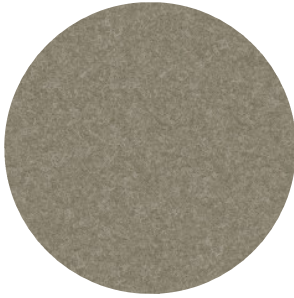

**Composition** 100% Recycled P.E.T. Felt, latex backing

**Weight** 1.000 g/m<sup>2</sup> | 29.49 oz/yd<sup>2</sup>

**Abrasion resistance** >7.000 Martindale

**Flammability** EU: EN 13501.1 + A1/2009 Class B-s1,d0  
USA: ASTM E84 Class A certified

**Fastness to light** USA 5



## Fabric

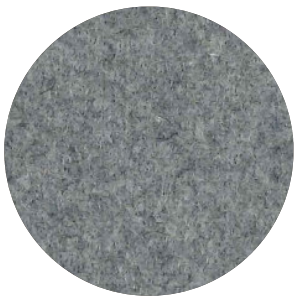

**Category** A

**Composition** 70% Recycled Wool, 25% Recycled Polyacryl,  
5% Recycled Other Fabrics

**Weight** 405 g/m<sup>2</sup> | 11.94 oz/yd<sup>2</sup>

**Abrasion resistance** 40.000 Martindale, 50,000 Wyzenbeek

**Flammability** EU: EN 1021.1/2006 | BS EN 1021.1/2006 (cigarette).  
EN 1021.2/2006 | BS EN 1021.2/2006 (match)

USA: CAL TB 117 | ASTM E84 CLASS A

**Fastness to light** EU 4 | USA 4

**Fastness to rubbing** EU: Wet 3-4 | Dry 4-5

**Fastness to crocking** USA: Wet 5 | Dry 5



## Hero

kvadrat

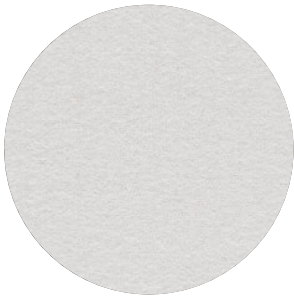

**Category** C

**Composition** 96% new wool, 4% nylon

**Weight** 580 g/lin.m

**Abrasion resistance** 45.000 Martindale rubs, EN ISO 12947

**Flammability** EN 1021-1/2 | DIN 4102 B2 | NF D 60 013

UNI 9175 1IM | US Cal. Bull. 117-2013 | NFPA 260  
IMO A.652 (16)

**Fastness to light** Note 5-6, ISO 105-B02

**Fastness to rubbing** (ISO) dry 4-5, wet 4-5

**Pilling** Note 3-4, EN ISO 12945



---

## Lace

Lace black | white | fluorescent orange





# Photometric Data

## BuzziShade LED Globe

To enlight your room with a lux level of 100 lux take following measures into account.

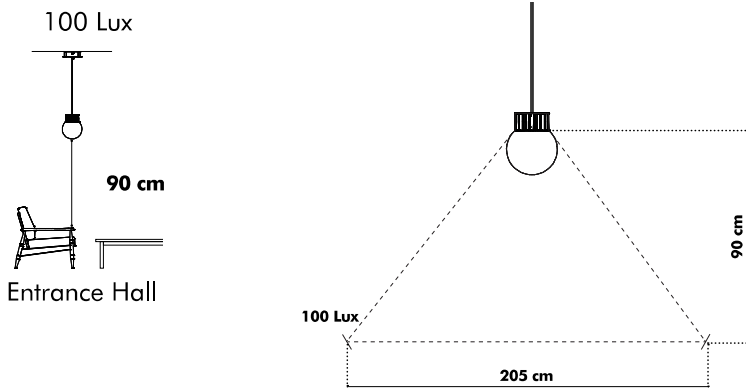

\* According to EN12464

**Globe Cartesian diagram**

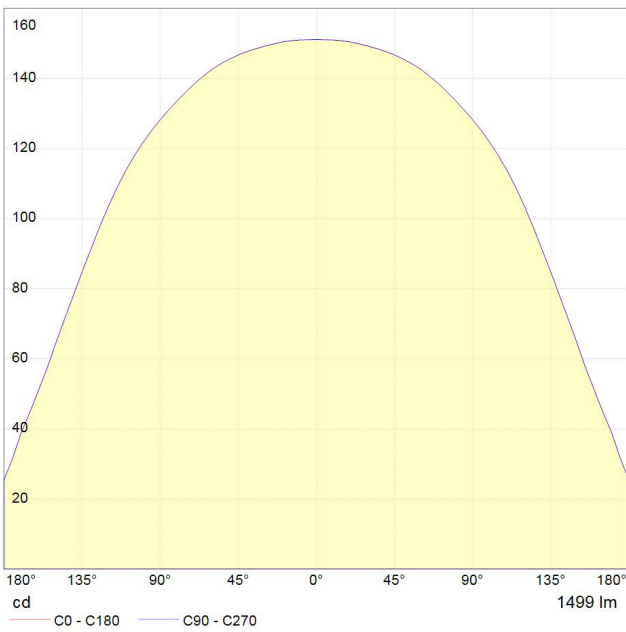

**Globe Polar curve**

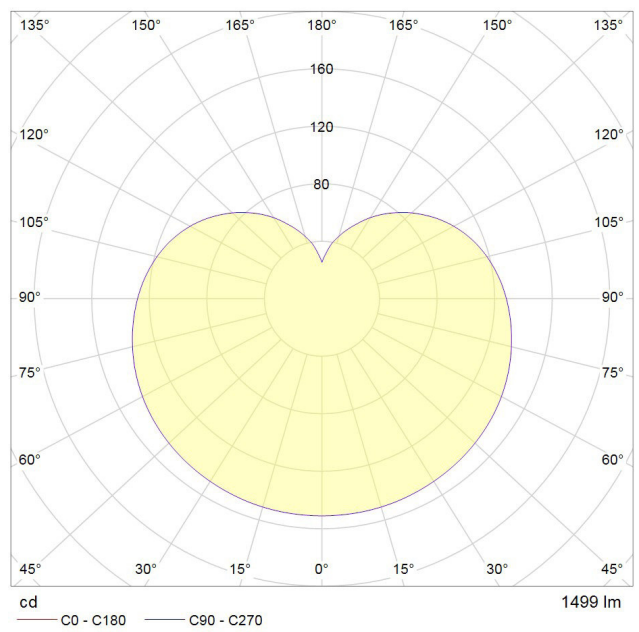

# BuzziShade LED Spot

To enlight your workplace or room with optimal lux levels take following measures into account.

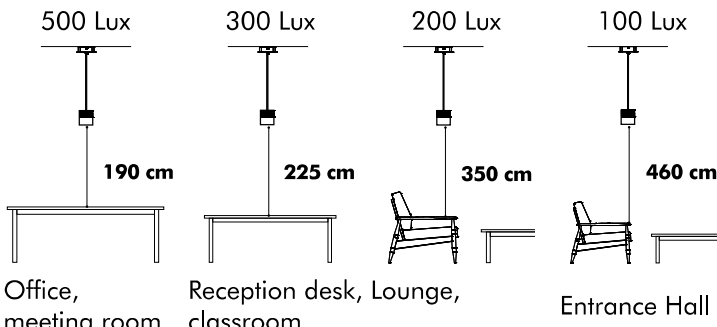

\* According to EN12464

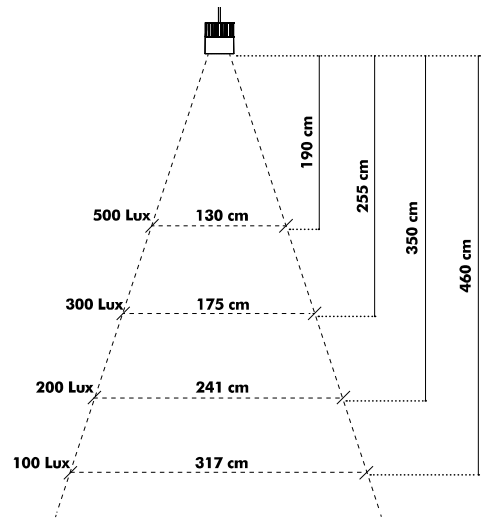

## Globe Cartesian diagram

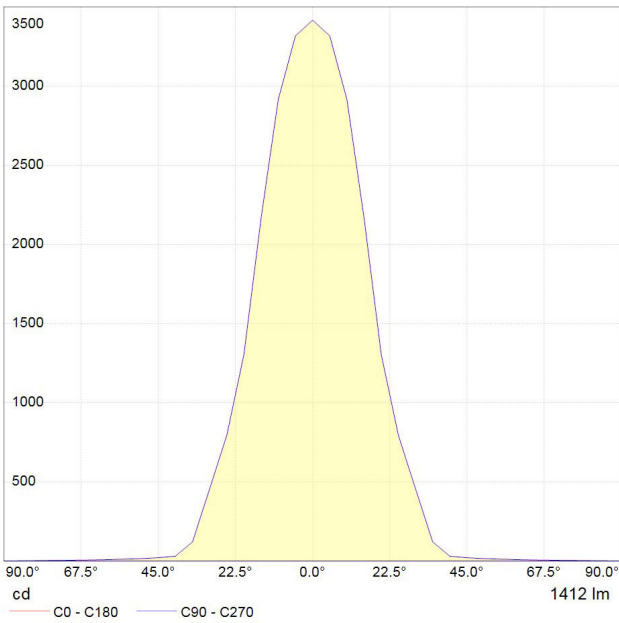

## Globe Polar curve

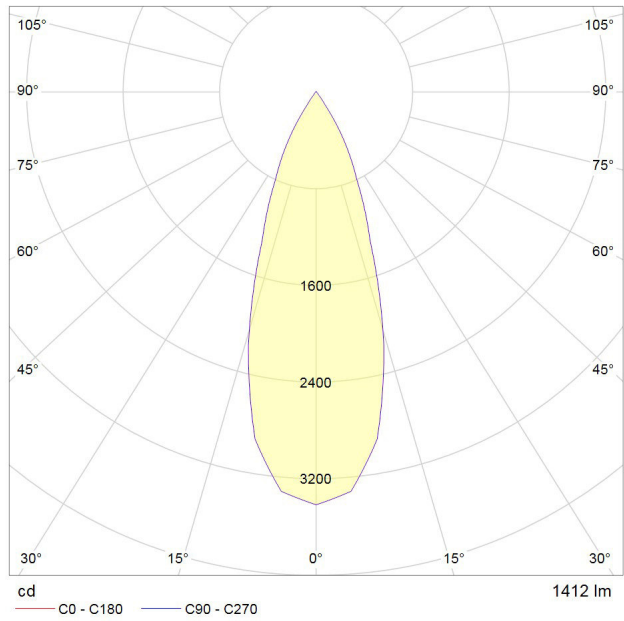

# Dimensions

## BuzziShade Pendant Medium

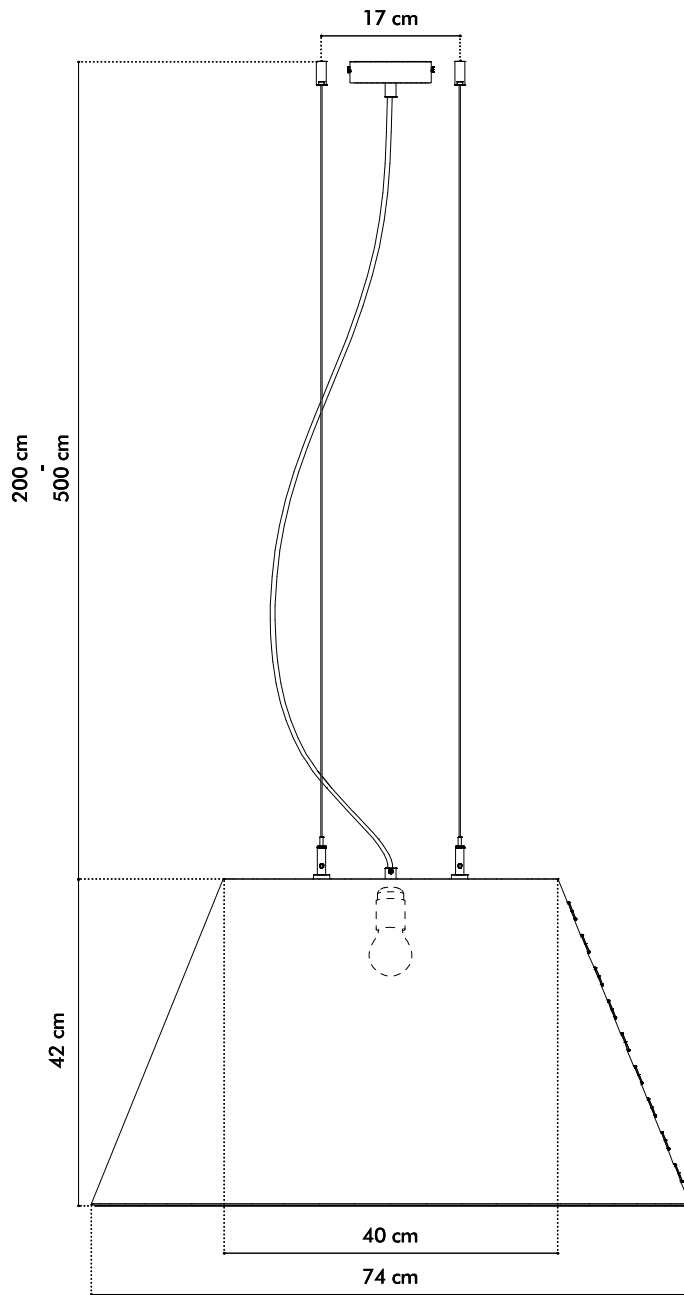

# BuzziShade Pendant LED Medium

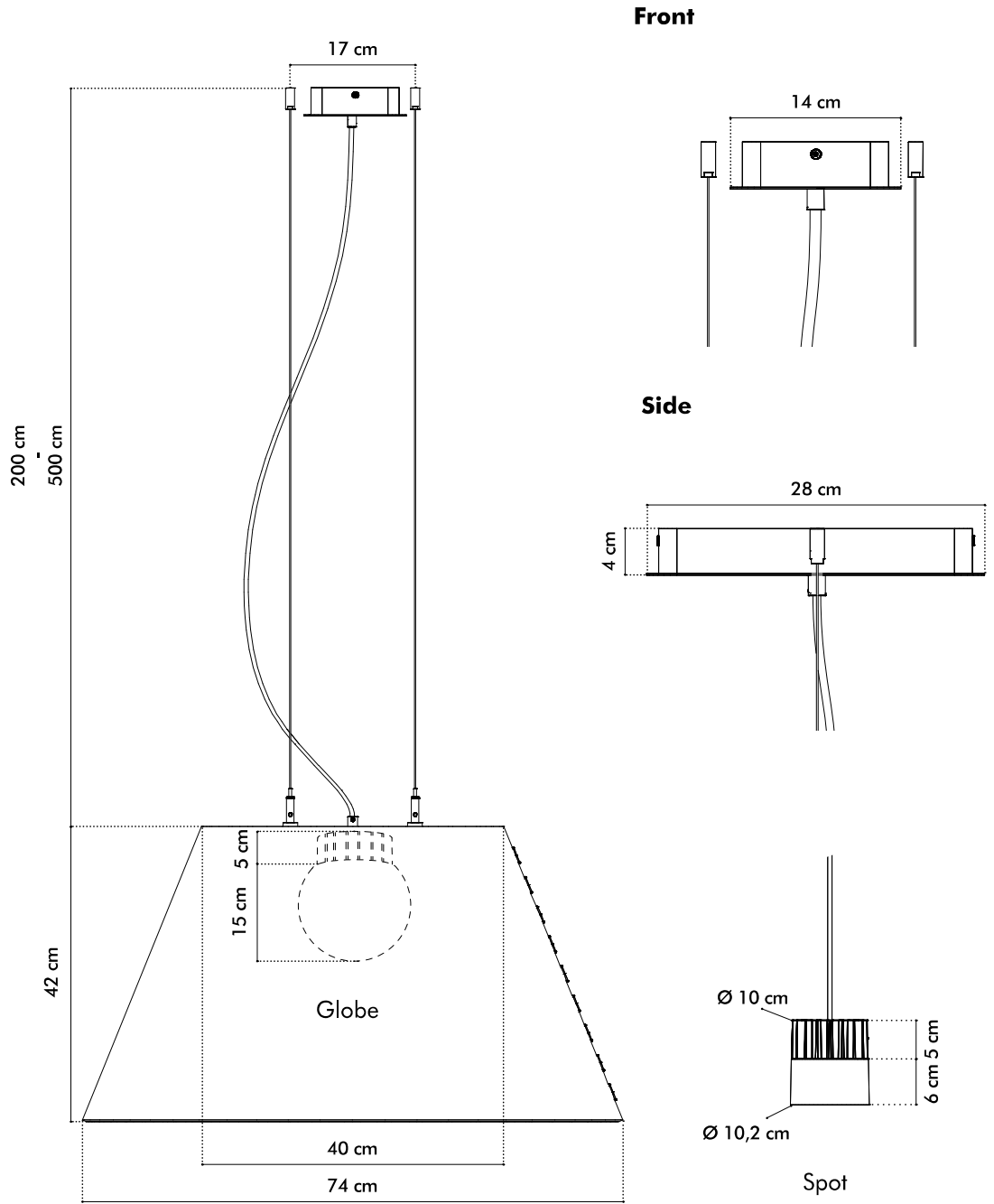

---

## BuzziShade Pendant Large

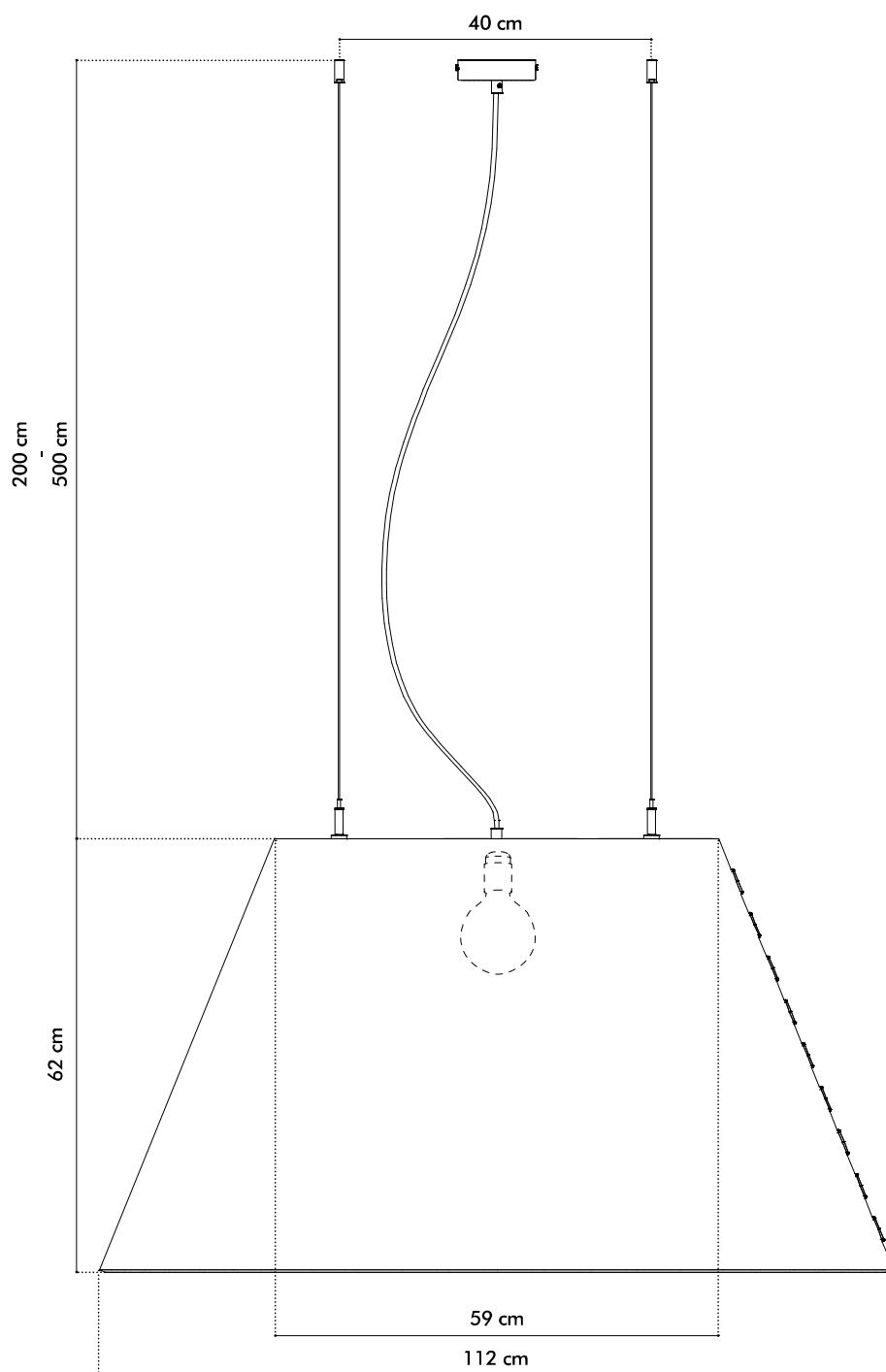

# BuzziShade Pendant LED Large

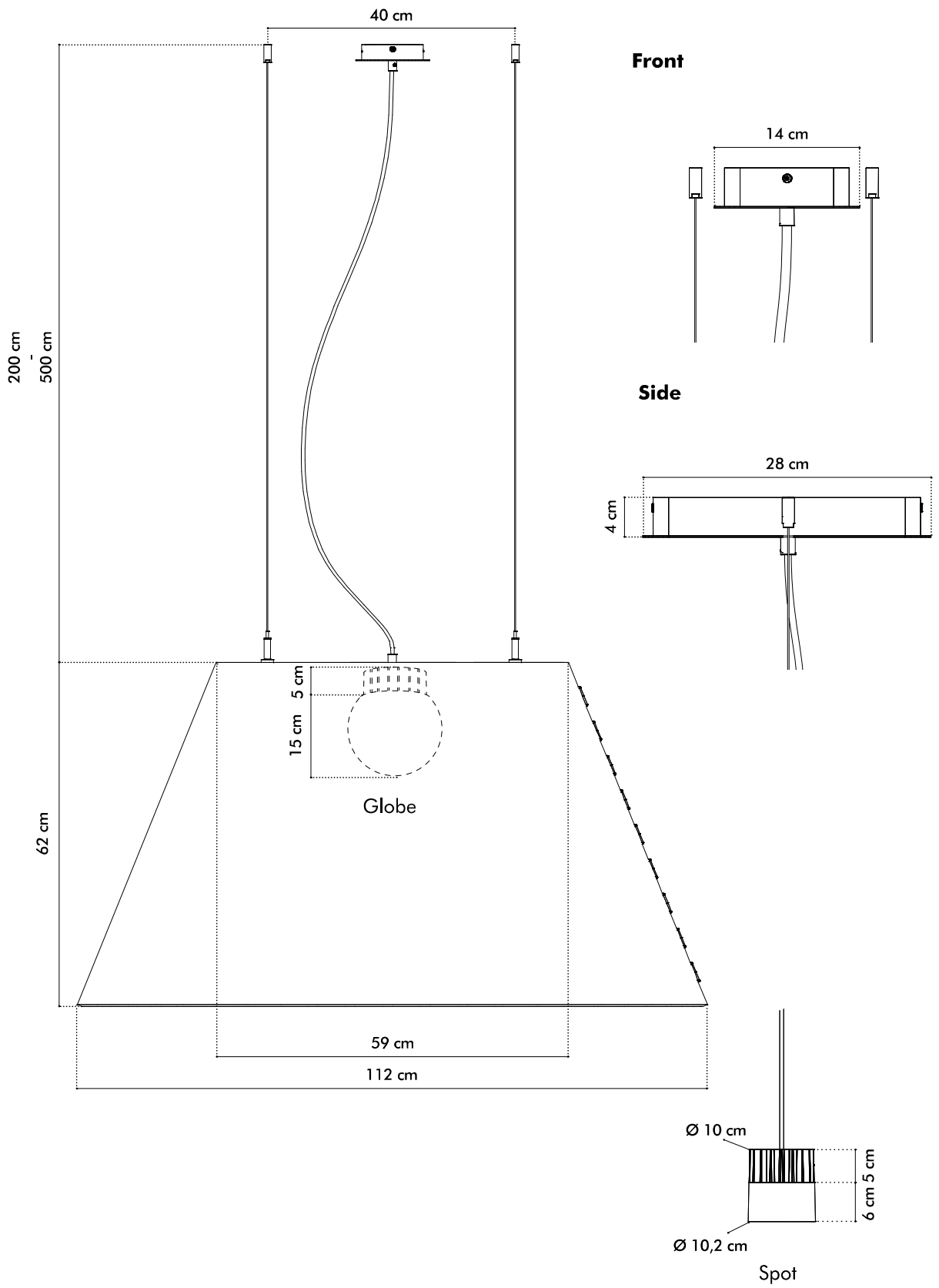

# Acoustics

## BuzziShade

Equivalent sound absorption area in m<sup>2</sup> per object

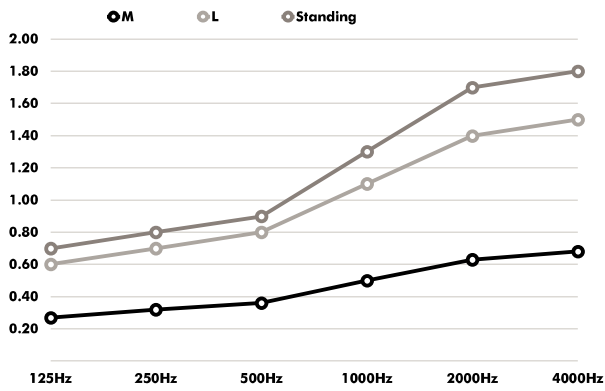

Hz	Shade M Aeq/m <sup>2</sup>	Shade L Aeq/m <sup>2</sup>	Shade Standing Aeq/m <sup>2</sup>
125	0.27	0.60	0.70
250	0.32	0.70	0.80
500	0.36	0.80	0.90
1000	0.50	1.10	1.30
2000	0.63	1.40	1.70
4000	0.68	1.50	1.80