**BuzziShade XL - XXL 230V
Product Specification Sheet**

This document contains technical
information about the BuzziShade XL - XXL







www.buzzi.space

The BuzziShade XL and XXL combine lit surroundings with acoustic performance.

Meet these new plus-size members of the iconic BuzziShade family. These oversized shades act as a cocoon with sound-absorbing capabilities, delimiting a space with elegance and silence. Being designed with a keen eye for details, its signature lacing complements this fancy acoustic lighting solution. Its bold personality makes a statement in lobbies, reception areas while reducing noise levels to a minimum. Thanks to the big surface it covers, it traps sound waves as they travel up-wards and prevents sound waves from bouncing. Match BuzziShade X(X)L with other furniture in your interior to have an outstanding well- balanced experience. In this case: the bigger, the better.

Designed by Stal Collectief

General

-  XL - XXL
 - BuzziFelt cover
 - Powder coated metal frame
-  LED disk with opaque diffusor
 - Powder coated metal ceiling canopy in white (RAL 9010)
 - Transparent power cable (4 m)
-  Wattage: 29W
 - Input Voltage: 230V
 - Input Frequency: 50/60Hz
 - Lumen Output: 2545 lumen
 - Color Temperature: 3000K (4000K on request)
 - Color Rendering Index: >90
 - Dimmable: 1-10V Protocol (DALI on request)
 - Unified Glare Rating: 22 (UGR 19 on request)
-  Dry usage
-  Assembled

Acoustics



Absorption

Certifications

CE/CB

Content

Configurations	3	Dimensions	7
Composition	4	Acoustics	9
Fabrics	5		

Configurations

BuzziShade XL

- ◆ XL
- 🌲 BuzziFelt cover with lace
- 🌲 Metal frame in black (RAL 9005), white (RAL 9010) or Uncoated Aluminium
- Height: 84 cm
- ✂ Diameter: Ø 75 cm
Ø 153 cm
- ⚖ 21,2 kg
- Lace: black | white
- ... Optional extra layer Fabric | Terra | Hero inside or outside
- Black or alu cables 2 - 4 m
- ⚠ If installing on suspended ceiling, verify load capacity prior to installation.

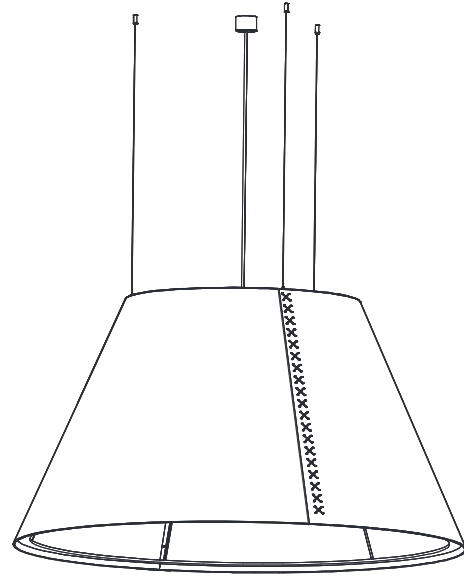

BuzziShade XXL

- ◆ XXL
- 🌲 BuzziFelt cover with lace
- 🌲 Metal frame in black (RAL 9005), white (RAL 9010) or Uncoated Aluminium
- Height: 104 cm
- ✂ Diameter: Ø 95 cm
Ø 193 cm
- ⚖ 25,7 kg
- Lace: black | white
- ... Optional extra layer Fabric | Terra | Hero inside or outside
- Black or alu cables 2 - 4 m
- ⚠ If installing on suspended ceiling, verify load capacity prior to installation.

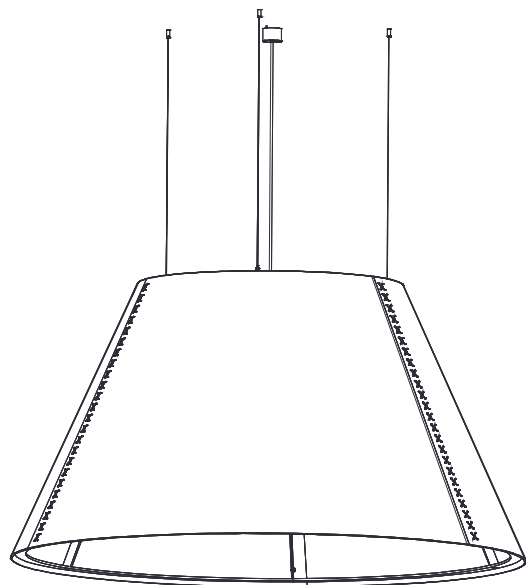

Composition

Light source

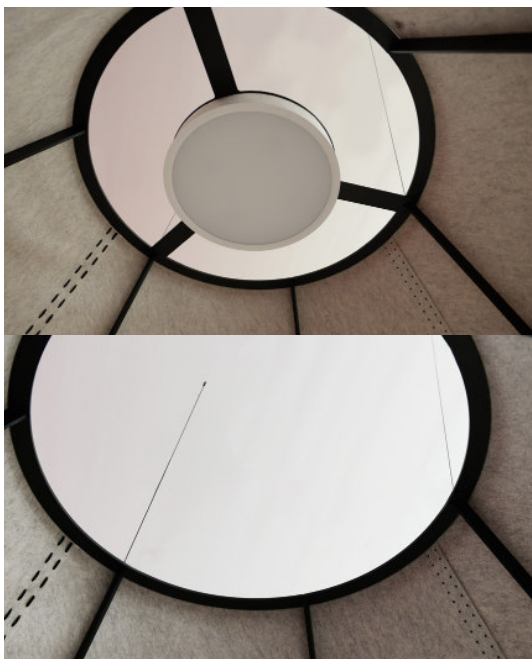

The PMMA diffuser ensures an optimal light spread and efficiency. It creates a very diffuse light surface without any dottiness. The light source of the BuzziShade XL | XXL is a LED PCB, containing 36 low power LED's.

On request, the BuzziShade XL or XXL can be ordered without LED light Source

Specification overview

Standard: 3000K | UGR 22 | 1-10V DIM
On request: 3000K | UGR 19 | 1-10V DIM
4000K | UGR 22 | 1-10V DIM
4000K | UGR 22 | DALI DIM
3000K | UGR 22 | DALI DIM

Ceiling canopy and power cord



Suspension set consists of a:

- metal ceiling canopy powder coated in white
- transparent power cable (length 4 m)
- 3 separate metal cables to suspend the BuzziShade XL | XXL (in alu or black 2 m or 4 m)

Frame

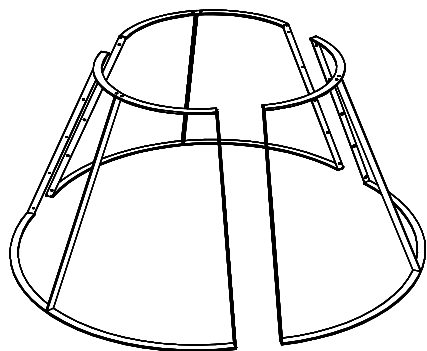

Metal frame is built up in 2 parts for XL and 3 parts for XXL

Metal frame available in following colors:

Powder coated white	RAL 9010
Powder coated black	RAL 9005
Alu	not powder coated

Fabrics

Felt

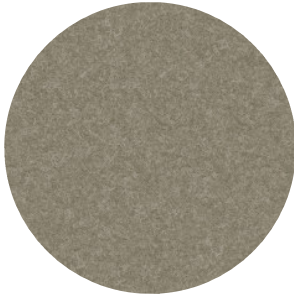

Composition 100% Recycled P.E.T. Felt, latex backing

Weight 1.000 g/m² | 29.49 oz/yd²

Abrasion resistance >7.000 Martindale

Flammability EU: EN 13501.1 + A1/2009 Class B-s1,d0
USA: ASTM E84 Class A certified

Fastness to light USA 5



Fabric

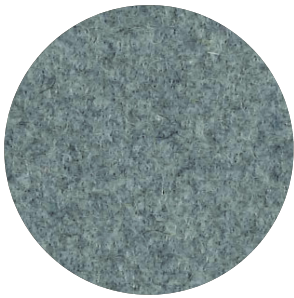

Category A

Composition 70% Recycled Wool, 25% Recycled Polyacryl,
5% Recycled Other Fabrics

Weight 405 g/m² | 11.94 oz/yd²

Abrasion resistance 40.000 Martindale, 50,000 Wyzenbeek

Flammability EU: EN 1021.1/2006 | BS EN 1021.1/2006 (cigarette).
EN 1021.2/2006 | BS EN 1021.2/2006 (match)

USA: CAL TB 117 | ASTM E84 CLASS A

Fastness to light EU 4 | USA 4

Fastness to rubbing EU: Wet 3-4 | Dry 4-5

Fastness to crocking USA: Wet 5 | Dry 5



Hero

kvadrat

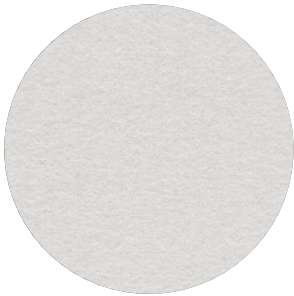

Category C

Composition 96% new wool, 4% nylon

Weight 580 g/lin.m

Abrasion resistance 45.000 Martindale rubs, EN ISO 12947

Flammability EN 1021-1/2 | DIN 4102 B2 | NF D 60 013

UNI 9175 11M | US Cal. Bull. 117-2013 | NFPA 260
IMO A.652 (16)

Fastness to light Note 5-6, ISO 105-B02

Fastness to rubbing (ISO) dry 4-5, wet 4-5

Pilling Note 3-4, EN ISO 12945



Lace

Lace black | white

Two rows of our signature lacing for model XL and three rows for model XXL

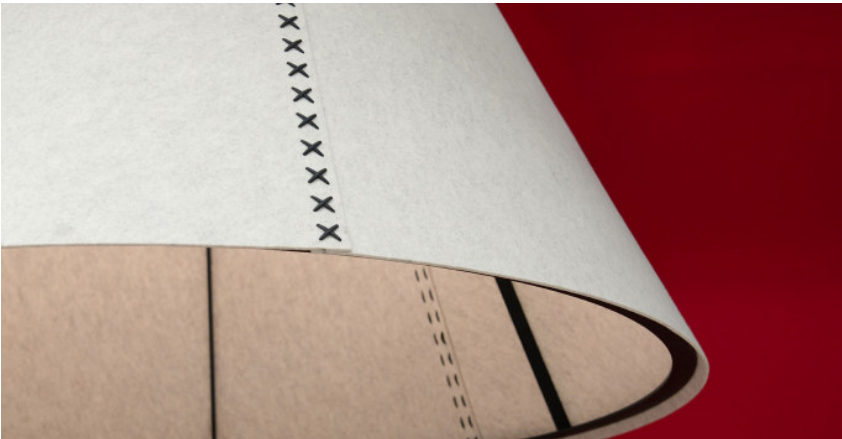

Dimensions

BuzziShade XL

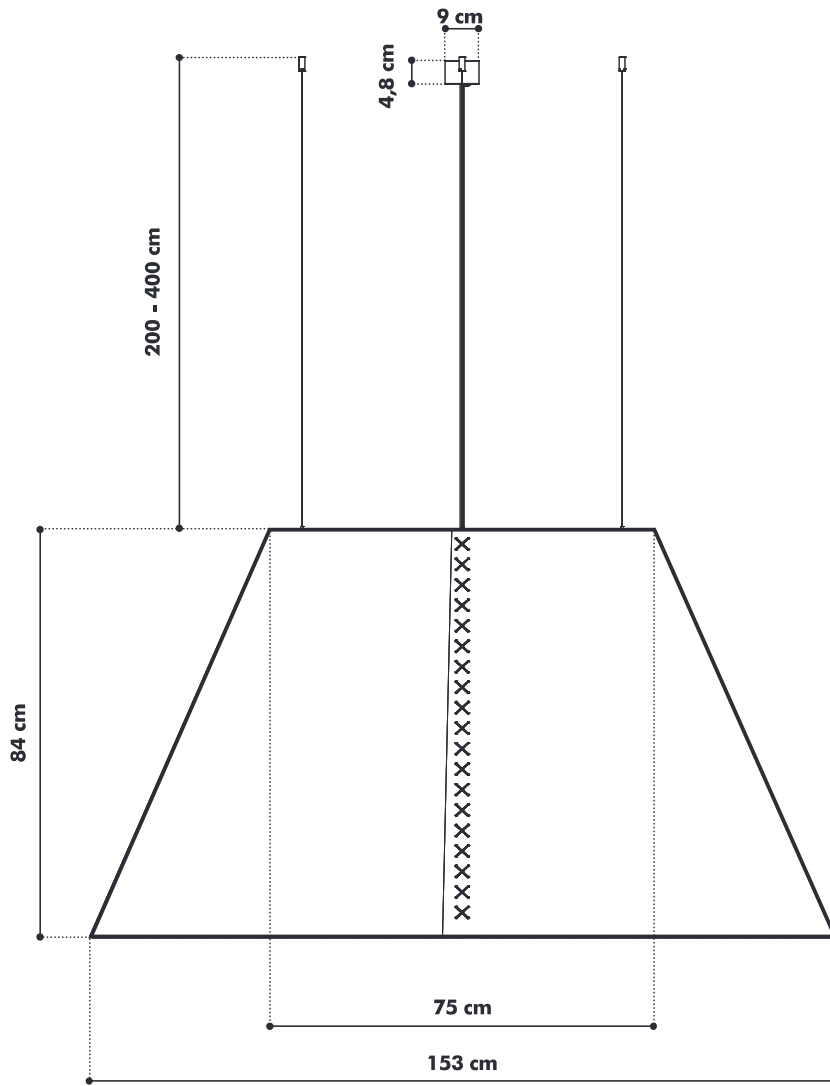

BuzziShade XXL

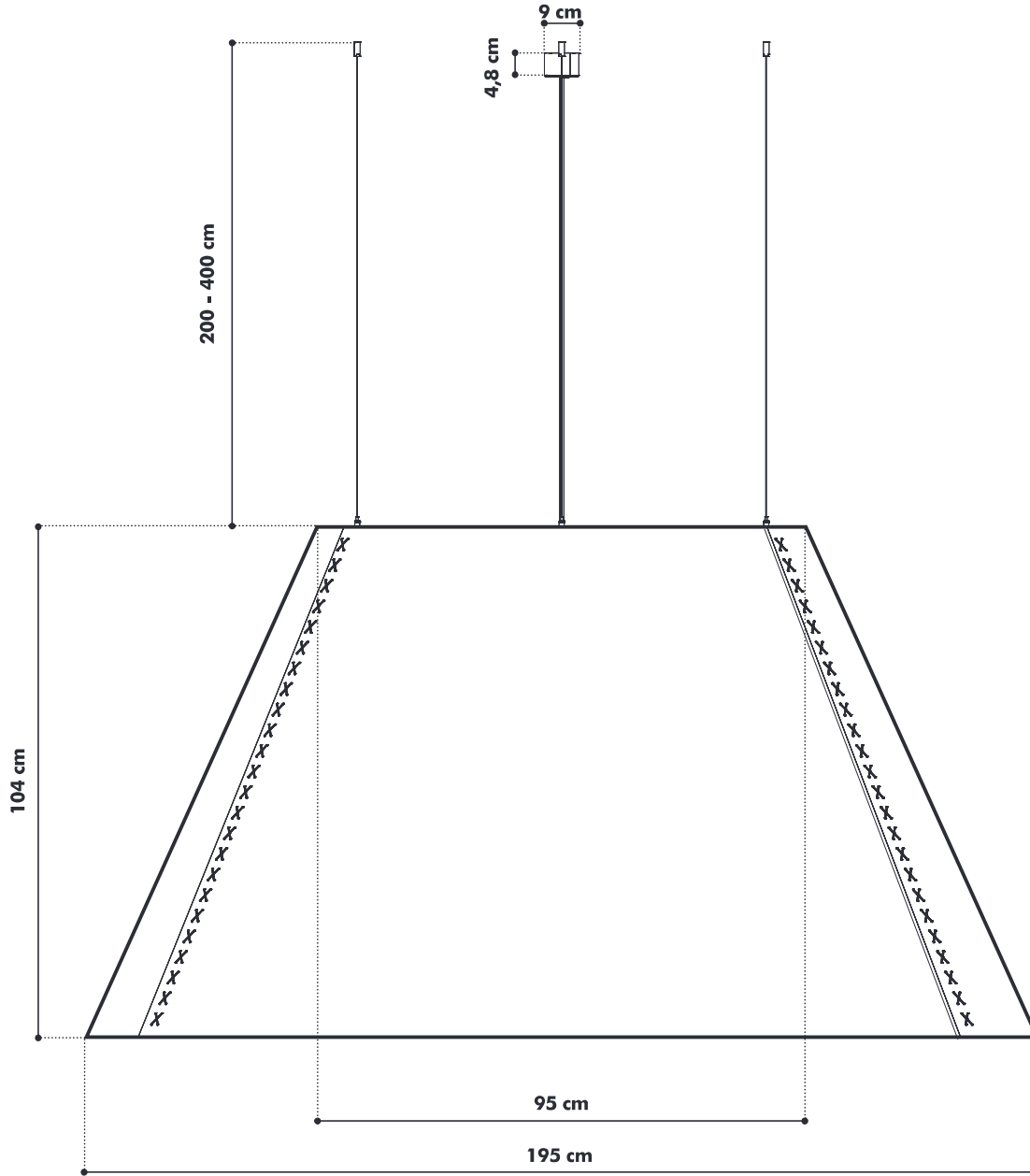

Acoustics

BuzziShade XL - XXL

Equivalent sound absorption area in m² per object



Hz	Shade XL Aeq/m ²	Shade XXL Aeq/m ²
125	1.00	1.51
250	1.52	2.09
500	2.03	2.55
1000	2.59	3.16
2000	3.15	4.06
4000	3.60	4.87