

---

# BuzziMilk

## product specification sheet

---

This documents contains technical information about the BuzziMilk Stool, Counter, Bar, Bench, Stool All Wood, Tile Small, Tile Large, Side Table, Side Table Large, Table

---



[www.buzzi.space](http://www.buzzi.space)



### A classic milk stool

This rustic-meets-modern take on the old farmhouse favorite would even make your grandma feel nostalgic. BuzziMilk is a sturdy little stool inspired by elements not usually found in a standard office space. Its goal? Create a warm and homey feeling at work. BuzziMilk has four legs and an upholstered seat for a softer experience. Select from a variety of wood finishes and make it your own by pairing with one of our many BuzziSpace fabrics. Looking for a pure wood stool? BuzziMilk Stool Allwood is pure simplicity and strong design.





### A versatile little table

The BuzziMilk base has inspired the handy BuzziMilk Tables. They can be grouped together to create a series of coffee or side tables, or used independently. Like the BuzziMilk design, multiple size and color options are possible.

Design by Alain Gilles

---

## General

-  BuzziMilk Stool, Counter, Bar, Bench, Stool All Wood, Tile Small, Tile Large, Side Table, Side Table Large, Table
-  Frame: Wood
-  Dry usage
-  Assembled

---

## Content

Configurations	3
Components	7
Fabrics	8
Finishes	12
Dimensions	13

# Configurations

---

## BuzziMilk Stool

📌 Stool

Frame in Ash Natural, Ash Black Stained, Ash White Wash, Walnut, Oak, Ash Lacquered White



Filling in C43170 foam

Seat upholstered in Fabric, Trevira CS+ | CS, Revive 1, Clara 2, Remix 3, Velvet, Hero, Tonus 4, Memory 2 or Leather Vegetal (Stitching is required for leather)



Stool: Ø 39 cm    H 47,5 cm  
          Ø 15.35"    H 18.70"



Stool: ± 5,9 kg | ± 13.01 lbs  
Max. weight capacity: 100 kg | 220.46 lbs

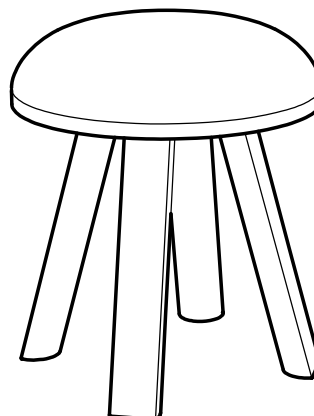

---

## BuzziMilk Counter

📌 Counter

Frame in Ash Natural, Ash Black Stained, Ash White Wash, Walnut, Oak, Ash Lacquered White



Filling in C43170 foam

Seat upholstered in Fabric, Trevira CS+ | CS, Revive 1, Clara 2, Remix 3, Velvet, Hero, Tonus 4, Memory 2 or Leather Vegetal (Stitching is required for leather)



Counter: Ø 39 cm    H 68 cm  
          Ø 15.35"    H 26.77"



Counter: ± 7,2 kg | ± 13.01 lbs  
Max. weight capacity: 100 kg | 220.46 lbs

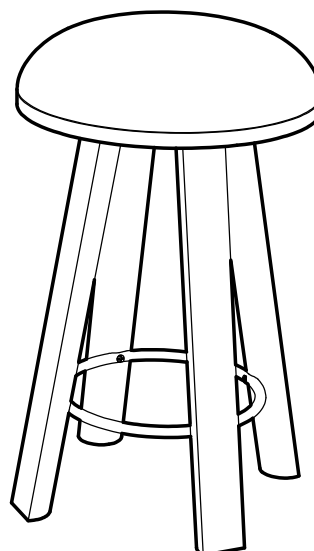

---

## BuzziMilk Bar

📌 Bar

Frame in Ash Natural, Ash Black Stained,  
Ash White Wash, Walnut, Oak,  
Ash Lacquered White



Filling in C43170 foam  
Seat upholstered in Fabric, Trevira CS+ | CS,  
Revive 1, Clara 2, Remix 3, Velvet, Hero,  
Tonus 4, Memory 2 or Leather Vegetal (Stitching  
is required for leather)



Bar: Ø 39 cm    H 78 cm  
      Ø 15.35"    H 30.71"



Bar: ± 7,8 kg | ± 17.20 lbs  
Max. weight capacity: 100 kg | 220.46 lbs

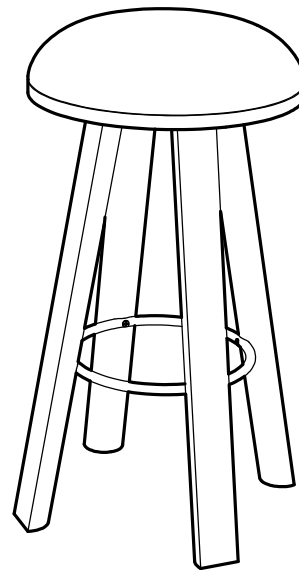

---

## BuzziMilk Bench

📌 Bench

Frame in Ash Natural, Ash Black Stained,  
Ash White Wash, Walnut, Oak,  
Ash Lacquered White



Filling in C43170 foam  
Seat upholstered in Fabric, Trevira CS+ | CS,  
Revive 1, Clara 2, Remix 3, Velvet, Hero,  
Tonus 4, Memory 2



Bench: W 39 cm    L 119 cm    H 48 cm  
      W 15.35"    L 46.85"    H 18.89"



Bench: ± 14,6 kg | ± 32.19 lbs  
Max. weight capacity: 150 kg | 330.69 lbs

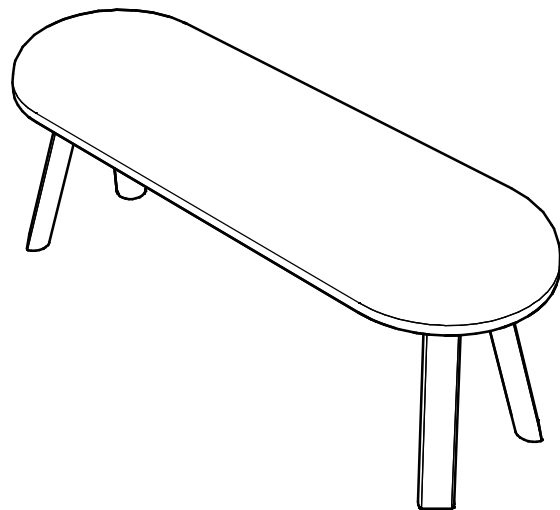

---

## BuzziMilk Stool All Wood

◆ Stool All Wood

Frame in Ash Natural, Ash Black Stained,  
Ash White Wash, Walnut, Oak,  
Ash Lacquered White

✂ Stool : Ø 39 cm H 43 cm  
Ø 15.35" H 16.93"

⚖ Stool: ± 6,5 kg | 14.33 lbs  
Max. weight capacity: 100 kg | 220.46 lbs

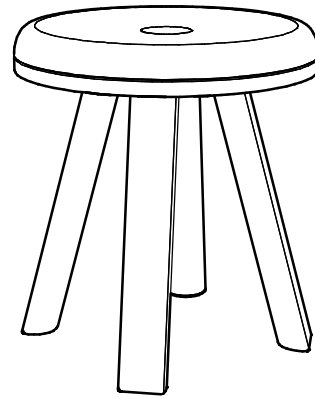

---

## BuzziMilk Tile Small

◆ Tile Small

Backplate 1,2 cm | 0.47" MDF  
Filling in C43170 foam

🌲 Upholstered in Fabric, Trevira CS+ |CS,  
Revive 1, Clara 2, Remix 3, Velvet, Hero,  
Tonus 4, Memory 2

✂ Ø 39 cm H 7,5 cm  
Ø 15.35" H 2.95

⚖ ± 1,30 kg  
± 2.87 lbs

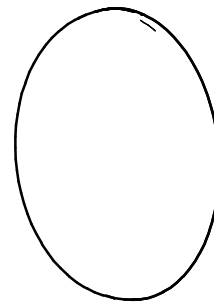

---

## BuzziMilk Tile Large

◆ Tile Large

Backplate 1,2 cm | 0.47" MDF  
Filling: C43170 foam

🌲 Upholstered in Fabric, Trevira CS+ |CS,  
Revive 1, Clara 2, Remix 3, Velvet, Hero,  
Tonus 4, Memory 2

✂ W 39 cm L 119 cm H 7,5 cm  
W 15.35" L 46.85" H 2.95"

⚖ ± 4,8 kg  
± 10.58 lbs

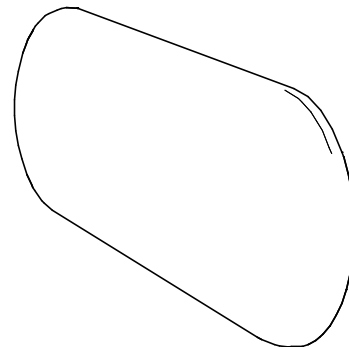

---

## BuzziMilk Side Table

Side Table

Frame in Ash Natural, Ash Black Stained,  
Ash White Wash, Walnut, Oak

Ø 39 cm H 39 cm  
Ø 15.35" H 15.35"

Side Table: ± 4,1 kg | ± 9.04 lbs  
Max. weight capacity: 100 kg | 220.46 lbs

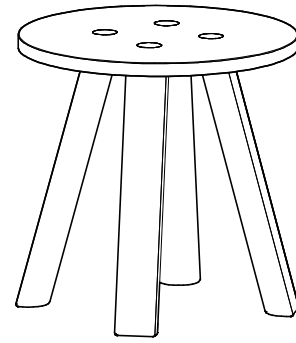

---

## BuzziMilk Side Table Large

Side Table Large

Frame in Ash Natural, Ash Black Stained,  
Ash White Wash, Walnut, Oak

W 39 cm L 119 cm H 39,5 cm  
W 15.35" L 46.85" H 15.55"

Side Table Large : ± 8,1 kg | ± 17.86 lbs  
Max. weight capacity: 50 kg | 110.23 lbs

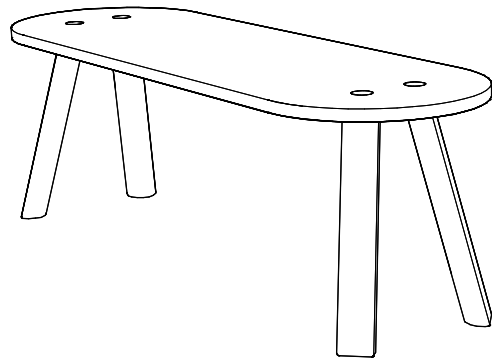

---

## BuzziMilk Table

Table

Frame in Ash Natural, Ash Black Stained,  
Ash White Wash, Walnut, Oak

Ø 100 cm H 73,5 cm  
Ø 39.37" H 28.94"

Table: 36 kg | 97.37 lbs

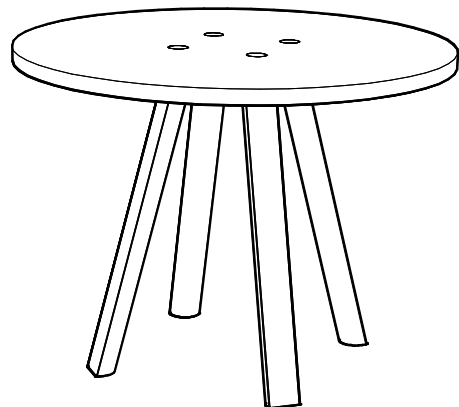

# Components



BuzziMilk has Felt or Plastic inserts



Black powder coated metal connection

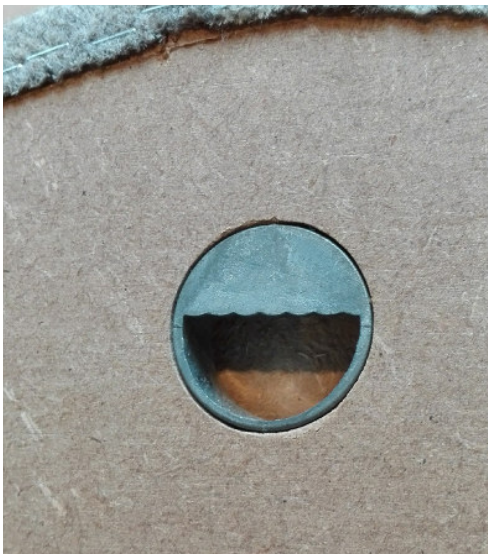

BuzziMilk Tile Fixing System.

1 pcs for Tile Small

3 pcs for Tile Large (horizontal or vertical mounting)

# Fabrics

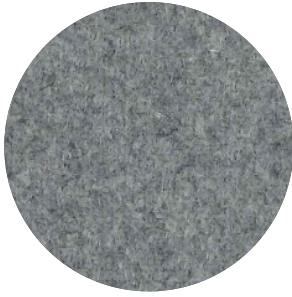

**Category A**

**Composition** 70% Recycled Wool, 25% Recycled Polyacryl,  
5% Recycled Other Fabrics

**Weight** 405 g/m<sup>2</sup> | 11.94 oz/yd<sup>2</sup>

**Abrasion resistance** 40.000 Martindale, 50,000 Wyzenbeek

**Flammability** EU: EN 1021.1/2006 | BS EN 1021.1/2006 (cigarette).  
EN 1021.2/2006 | BS EN 1021.2/2006 (match)  
USA: CAL TB 117 | ASTM E84 CLASS A

**Fastness to light** EU: 4 | USA 4

**Fastness to rubbing** EU: Wet 3-4 | Dry 4-5

**Fastness to crocking** USA: Wet 5 | Dry 5



---

## Trevira CS+ | CS

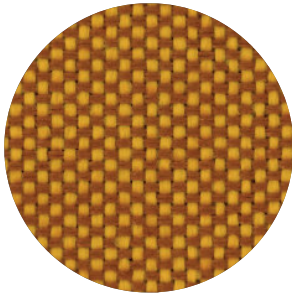

**Category A**

**Weight** 420 g/m<sup>2</sup> | 12.39 oz/yd<sup>2</sup>

**Composition** 100% Polyester, Trevira CS

**Abrasion resistance** 100.000 Martindale, 90,000 Wyzenbeek

**Flammability** BS 5852 part II: CRIB 5 | BS 7176 Medium Hazard  
USA: CAL TB 117 | M1 | B1 | EN 1021/1-2 | C1 |  
IMO Res. A652 (16)

**Fastness to light** EU: 6 | USA 5

**Fastness to rubbing** EU: Wet 4-5 | Dry 4-5

**Fastness to crocking** USA: Wet 5 | Dry 5



---

## Revive 1

kvadrat

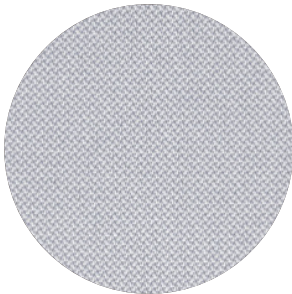

**Category A**

**Composition** 100% recycled polyester FR

**Weight** 430 g/lin.m

**Abrasion resistance** 60.000 Martindale rubs, EN ISO 12947

**Flammability** EN 1021-1/2 | DIN 4102 B1 | Önorm B1/Q1  
UNI 9175 11M | US Cal. Tech. Bull. 117  
IMO A.652 (16)

**Fastness to light** Note 5-7, ISO 105-B02

**Fastness to rubbing** (ISO) dry 5, wet 4-5

**Pilling** Note 4-5, EN ISO 12945





## Velvet

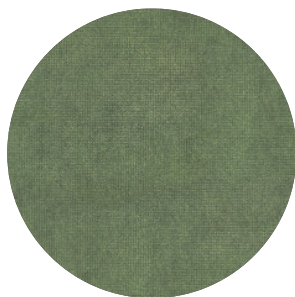

**Category** B  
**Composition** 100% PES  
**Weight** 375 g/m<sup>2</sup> | 11.06 oz/yd<sup>2</sup>  
**Abrasion resistance** > 100.000 Martindale  
**Fastness to light** EU: 4-5  
**Fastness to rubbing** EU: Wet 4 | Dry 4-5  
**Pilling** EU: 4-5

## Clara 2

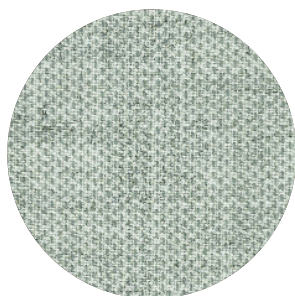

**Category** B  
**Composition** 92% new wool, 8% nylon  
**Weight** 400 g/lin.m  
**Abrasion resistance** 80.000 Martindale rubs, EN ISO 12947  
**Flammability** EN 1021-1/2 | BS 5852, ignition source 2-3 | DIN 4102 B2  
NF D 60 013 | UNI 9175 1IM | US Cal. Tech. Bull. 117, Sec. E  
NFPA 260 | IMO A.652(16)  
**Fastness to light** Note 5-7, ISO 105-B02  
**Fastness to rubbing** (ISO) dry 4-5, wet 4  
**Pilling** Note 4, EN ISO 12945



kvadrat

## Remix 3



**Category** B  
**Composition** 90% new wool, 10% nylon  
**Weight** 415 g/lin.m  
**Abrasion resistance** 100.000 Martindale rubs, EN ISO 12947  
**Flammability** EN 1021-1/2 | BS 5852 part 1  
Önorm B1/Q1 | NF D 60 013 | UNI 9175, 1IM  
AS/NZS 1530.3 | Cal. Tech. Bull. 117-2013  
NFPA 260 | IMO FTP Code 2010:Part 8  
**Fastness to light** Note 5-7, ISO 105-B02  
**Fastness to rubbing** (ISO) dry 4-5, wet 4  
**Pilling** Note 4, EN ISO 12945



kvadrat

## Hero

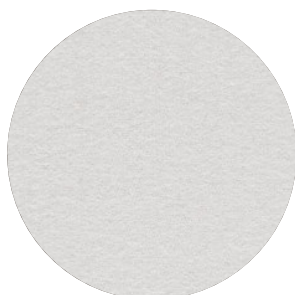

**Category** C  
**Composition** 96% new wool, 4% nylon  
**Weight** 580 g/lin.m  
**Abrasion resistance** 45.000 Martindale rubs, EN ISO 12947  
**Flammability** EN 1021-1/2 | DIN 4102 B2 | NF D 60 013  
UNI 9175 1IM | US Cal. Bull. 117-2013 | NFPA 260  
IMO A.652 (16)  
**Fastness to light** Note 5-6, ISO 105-B02  
**Fastness to rubbing** (ISO) dry 4-5, wet 4-5  
**Pilling** Note 3-4, EN ISO 12945



kvadrat

## Tonus 4

kvadrat



**Category D**

**Composition** 90% new wool, 10% Helanca

**Weight** 665 g/lin.m

**Abrasion resistance** 100.000 Martindale rubs, EN ISO 12947

**Flammability** EN 1021-1/2 | BS 5852 part 1 | DIN 4102 B2

Önorm B1/Q1 | NF D 60 013 | UNI 9175 1IM

US Cal. Bull. 117-2013 | NFPA 260 | IMO A.652 (16)

**Fastness to light** Note 5-7, ISO 105-B02

**Fastness to rubbing** (ISO) dry 3-5, wet 3-5

**Pilling** Note 3, EN ISO 12945



## Memory 2

kvadrat

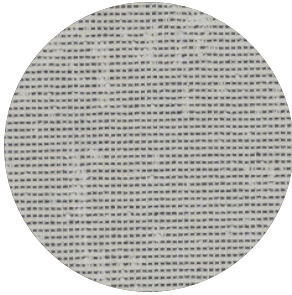

**Category E**

**Composition** 100% Trevira CS

**Weight** 700 g/lin.m

**Abrasion resistance**

35.000 rubs acc. to the Martindale method, EN ISO 12947

**Flammability** EN 1021-1/2 | DIN 4102 B1 | Önorm B1/Q1

NF D 60 013 | NF P 92 507 M1 | UNI 9175 1IM

UNI 9177 classe 1 | US Cal. Tech. Bull. 117

IMO A.652 (16)

**Fastness to light** Note 5-8, ISO 105-B02

**Fastness to rubbing** (ISO) dry 4-5, wet 4-5

**Pilling** Note 4, EN ISO 12945



## Leather Vegetal



**Raw material** Scandinavian Bullhides

**Surface** Pure Aniline

**Flammability** EU: EN 1021.1 - BS5852 PART 1 (cigarette)

EN 1021.2 - BS5852 PART 1 (match)

USA: CAL TB 117

**Fastness to light** EU: 3 Blue Scale (72h exposition)

**Fastness to rubbing** EU: Wet: 20 cycles/3 | Dry: 50 cycles/3

Sweat: 20 cycles/3

**Strenght** Tear resistance: >20N or 10N/mm thickness

Tensile: >20N/mmq

Elongation: 40-70%

# Finishes

---

## Wood

for Base and Tabletop



Ash Natural



Ash Black Stained



Ash White Wash



Walnut



Oak



Ash Lacquered  
White\*

\* Not available for Side Table, Side Table Large, Table

# Dimensions

## Stool

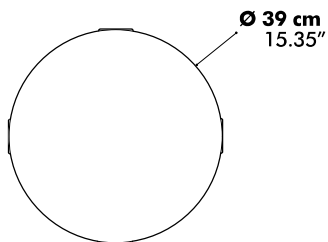
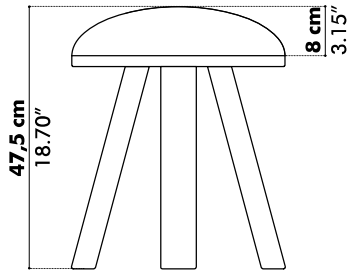

## Counter

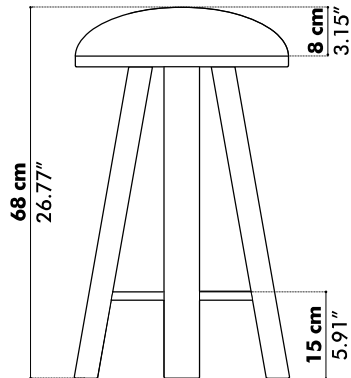

## Bar

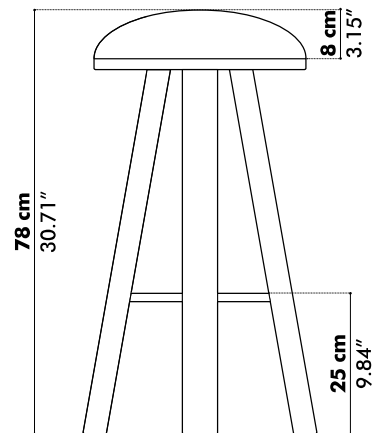

## Bench

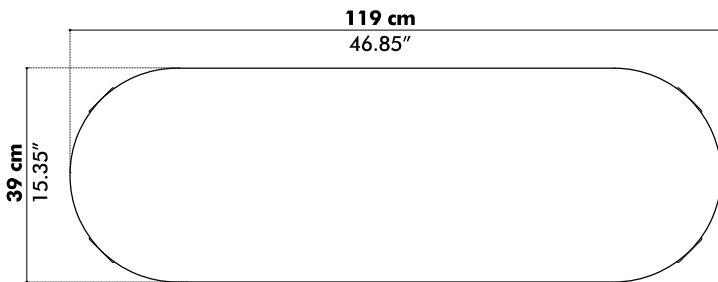

## Stool All Wood

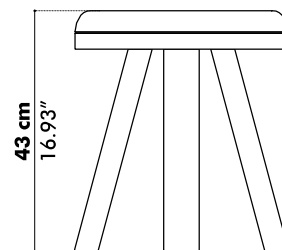
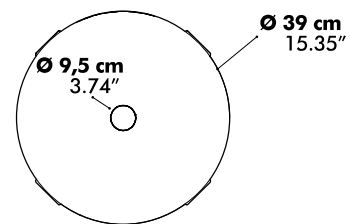

---

## Tile Small

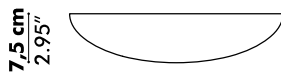
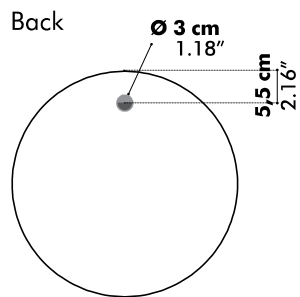
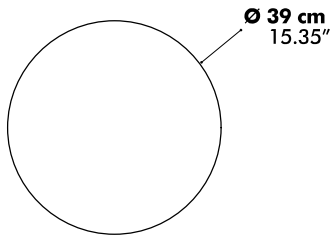

---

## Tile Large

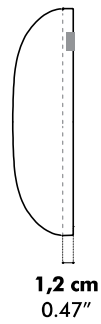
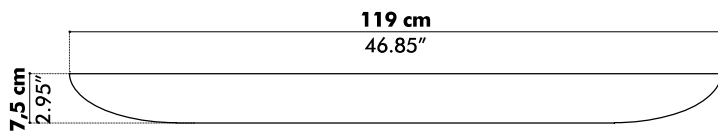
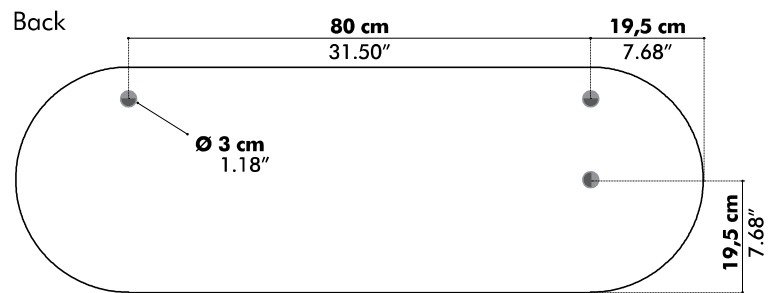
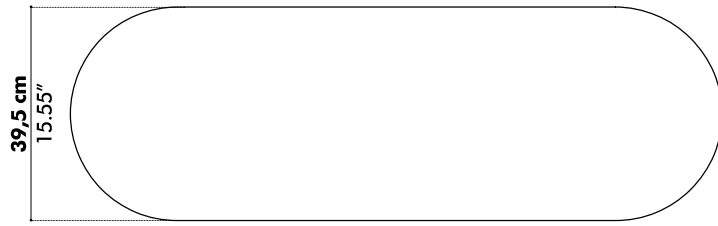

---

## Side Table

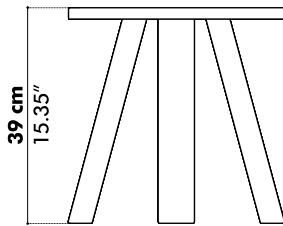
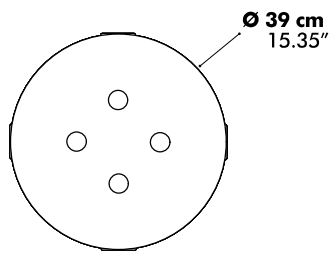

---

## Side Table Large

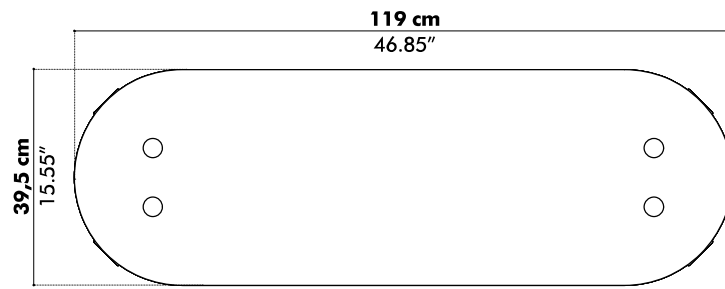

---

## Table

